

SPECIALS

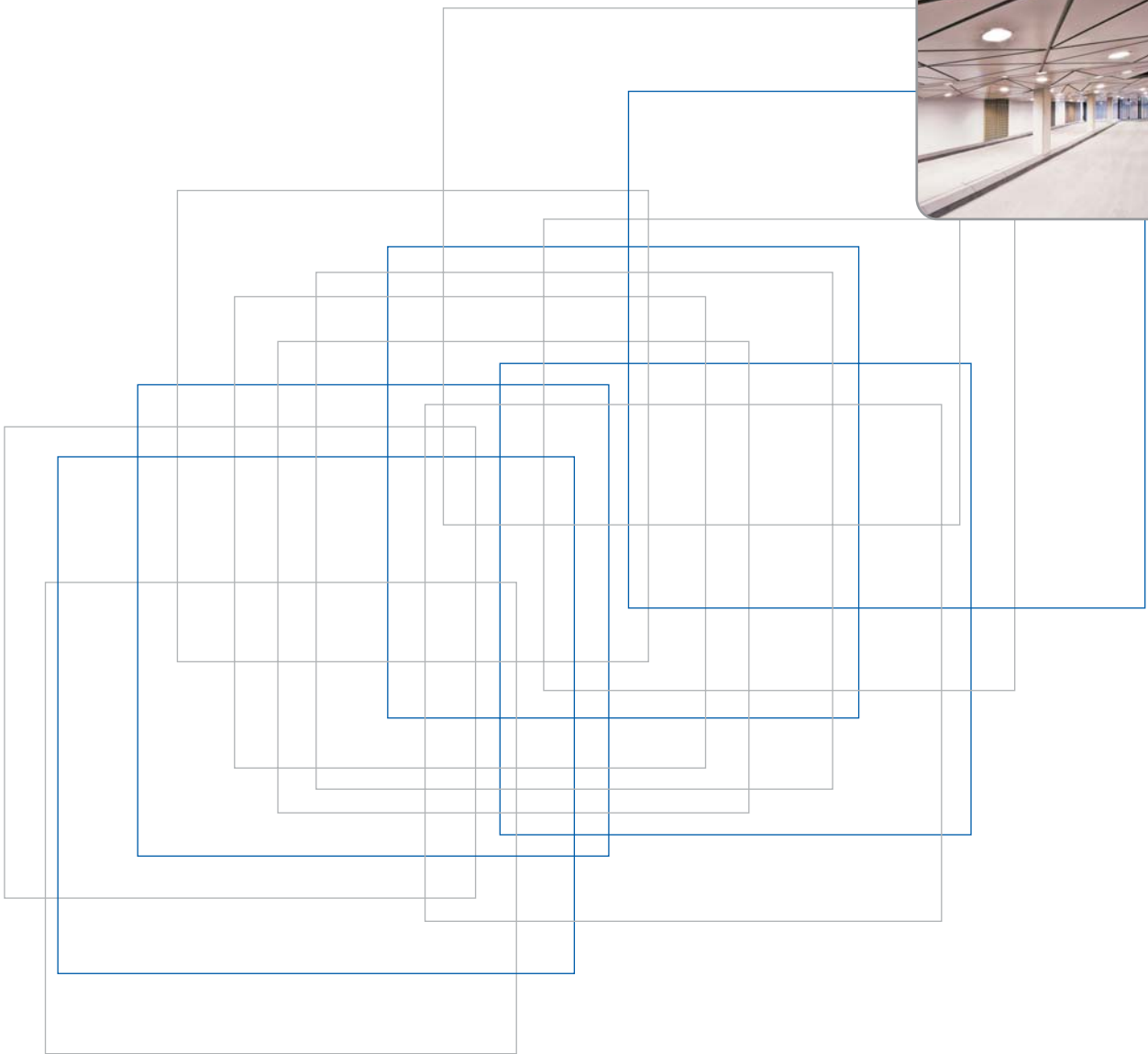

METAL CEILING SYSTEMS

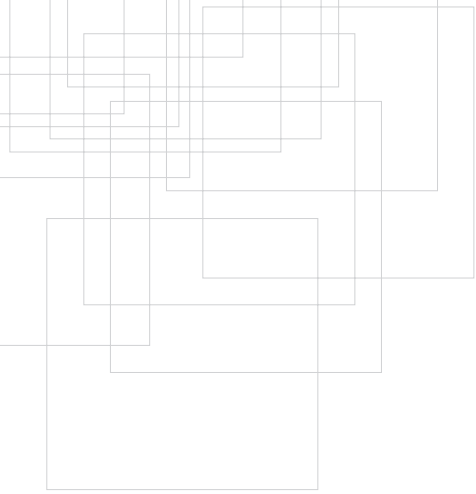



INTEGRA TILE



INTEGRA PLANK



INTEGRA OPEN CELL



INTEGRA EXPANDED



INTEGRA SPECIALS



In addition to Integra's standard product range, Integra Specials enables a greater degree of design creativity with its curved, island, trapezoidal forms.

CURVILINEAR PANELS



S PANEL
C PANEL

TRAPEZOIDAL PANELS



ISLAND PANELS





CURVED CEILINGS-S

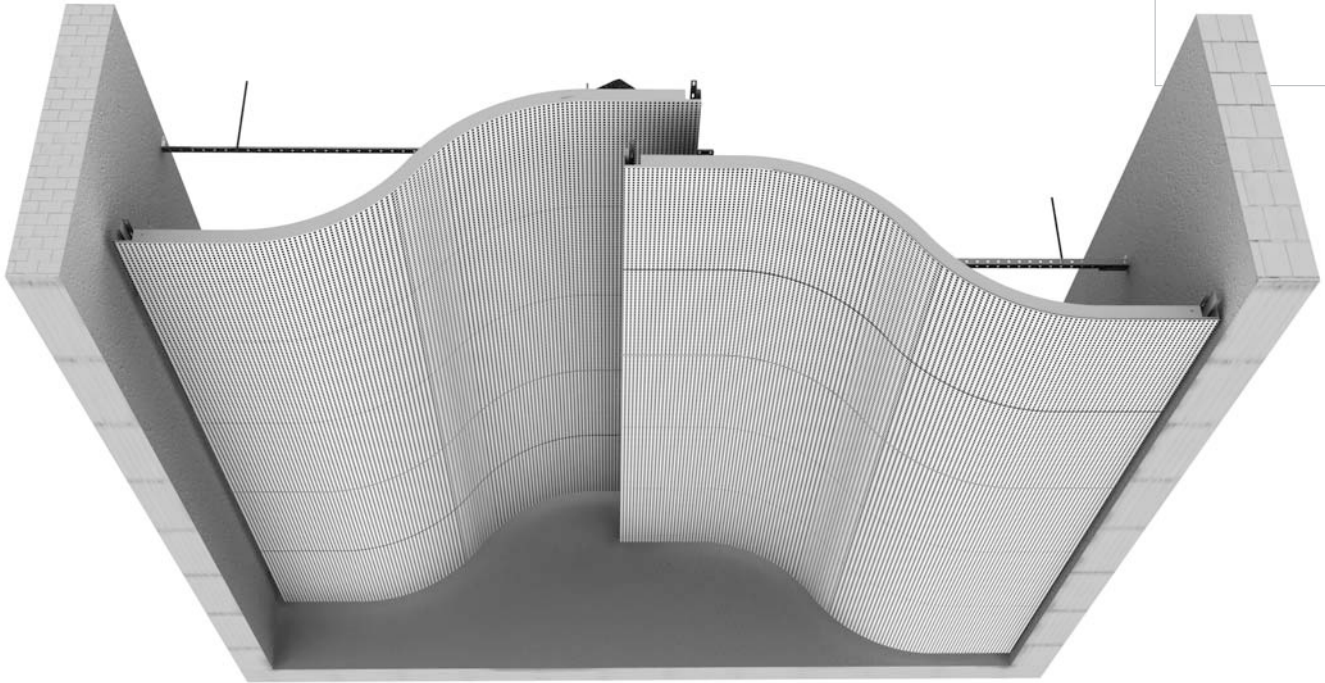

Material	Galvanized Steel, Aluminum
Dimension	Width: 200-1000 mm Length: 2000 mm(max.)
Standard Perforation (mm)	Ø0.7, Ø1.5, Ø 1.8, Ø2.5, Ø3.0, Ø7.0
Special Perforation (mm)	Ø4.5, Ø12.0, 8x8 square
Acoustics	NRC:0,60-0,70
Fire	Reaction to Fire Class B-s1,d0

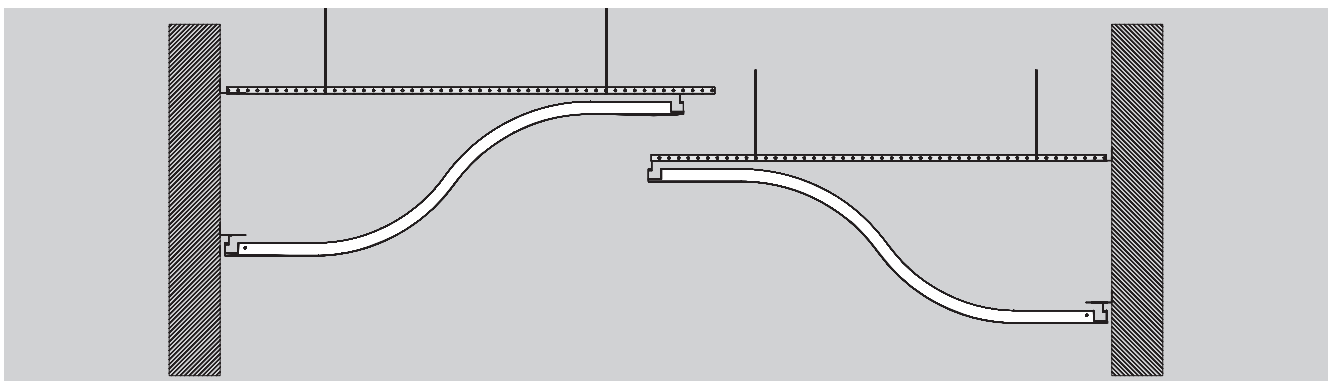



CURVED CEILING-C

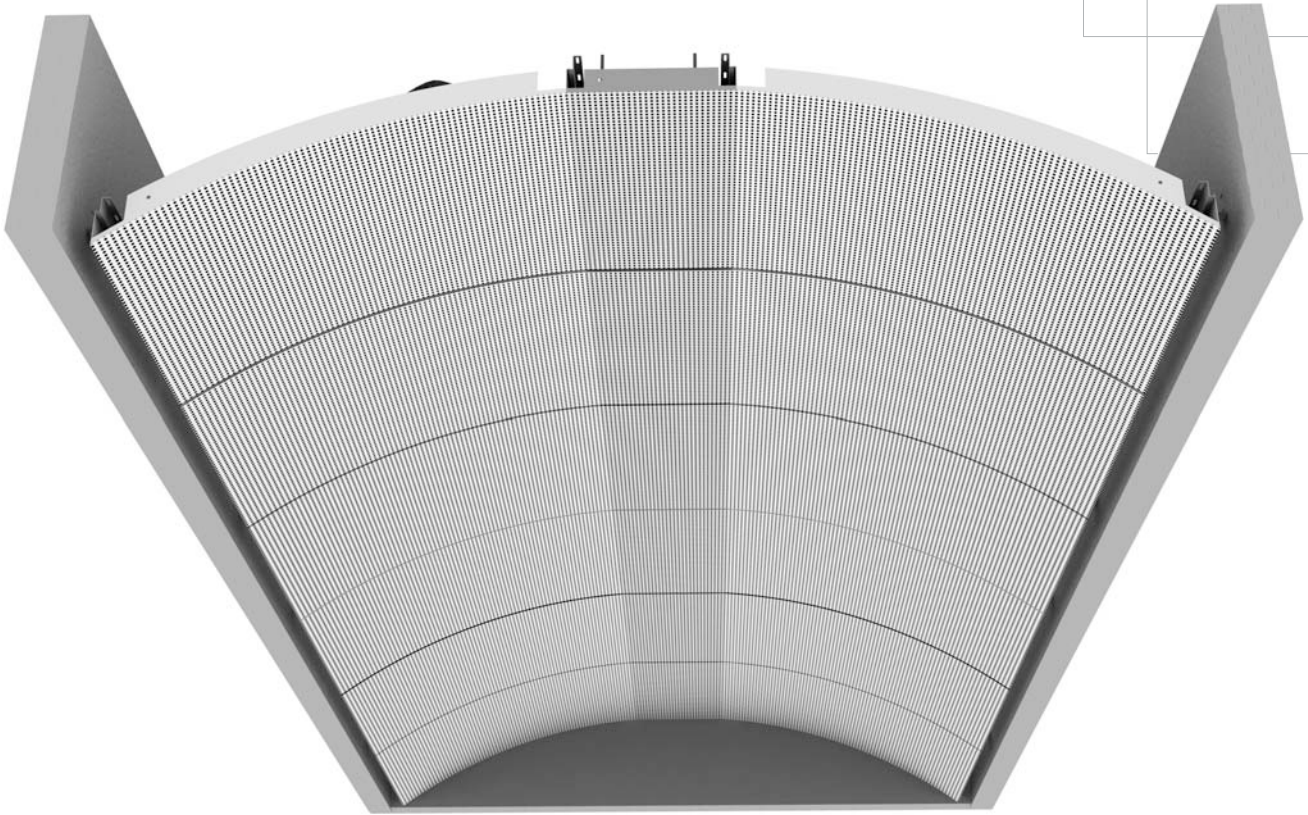

Material	Galvanized Steel, Aluminum
Dimension	Width: 200-1000 mm Length: 2000 mm(max.)
Standard Perforation (mm)	Ø0.7, Ø1.5, Ø1.8, Ø2.5, Ø3.0, Ø7.0
Special Perforation (mm)	Ø4.5, Ø12.0, 8x8 square
Acoustics	NRC:0,60-0,70
Fire	Reaction to Fire Class B-s1,d0

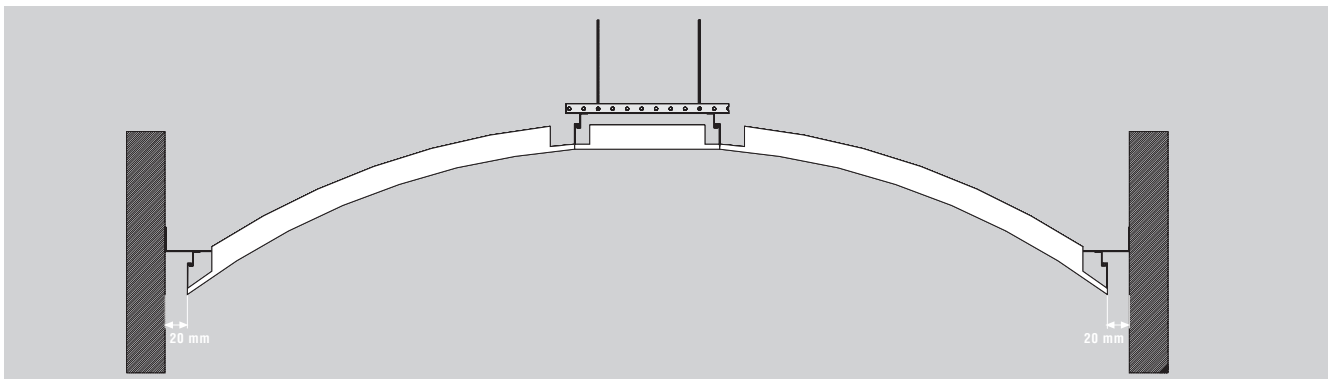





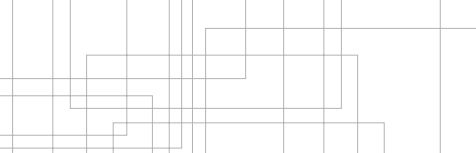

TRAPEZOIDAL CEILINGS

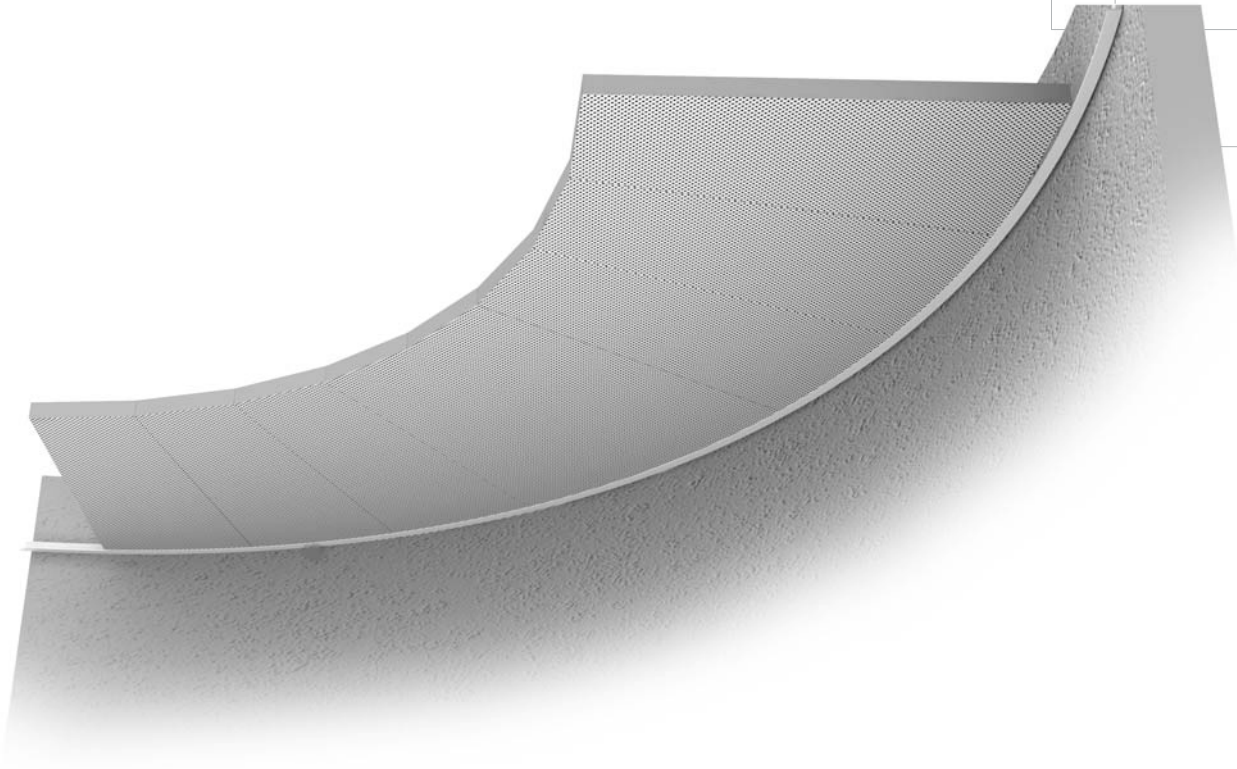

Material	Galvanized Steel, Aluminum
Dimension	Width: 200-1000 mm Length: 2500 mm(max.)
Standard Perforation (mm)	Ø0.7, Ø1.5, Ø 1.8, Ø2.5, Ø3.0, Ø7.0
Special Perforation (mm)	Ø4.5, Ø12.0, 8x8 square
Acoustics	NRC:0,60-0,70
Fire	Reaction to Fire Class B-s1,d0

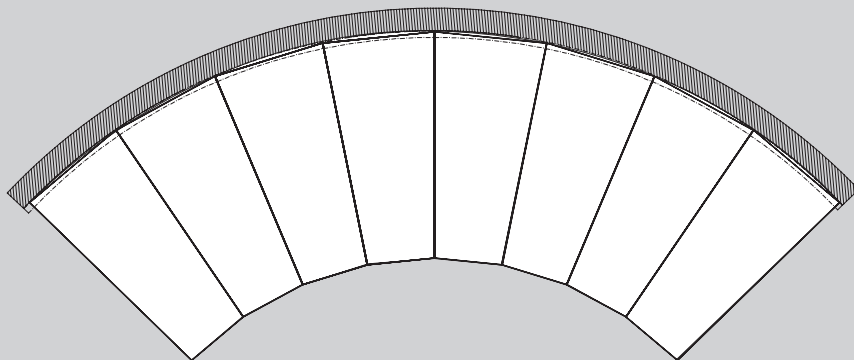

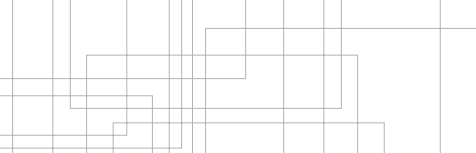

ISLAND CEILINGS

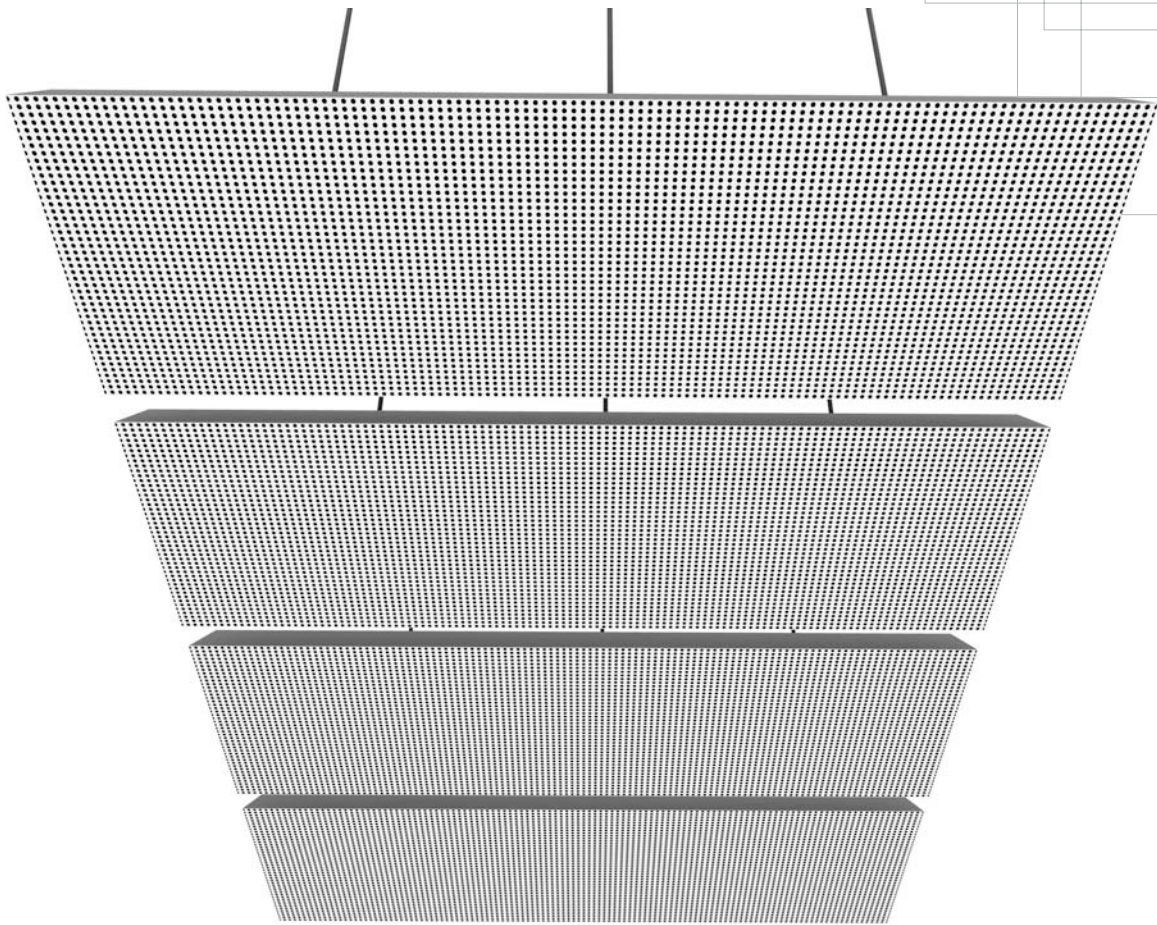

Material	Galvanized Steel, Aluminum
Dimension	Width: 200-1000 mm Length: 3000 mm(max.)
Standard Perforation (mm)	Ø0.7, Ø1.5, Ø 1.8, Ø2.5, Ø3.0, Ø7.0
Special Perforation (mm)	Ø4.5, Ø12.0, 8x8 square
Acoustics	NRC:0,60-0,70
Fire	Reaction to Fire Class B-s1,d0

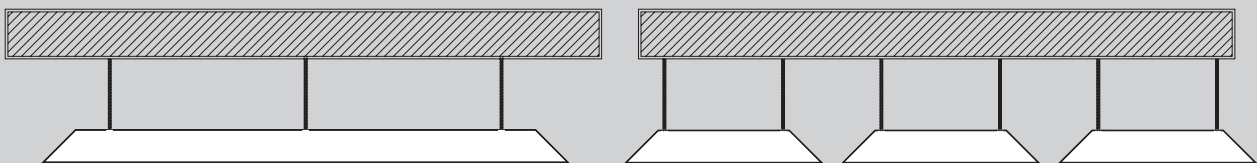
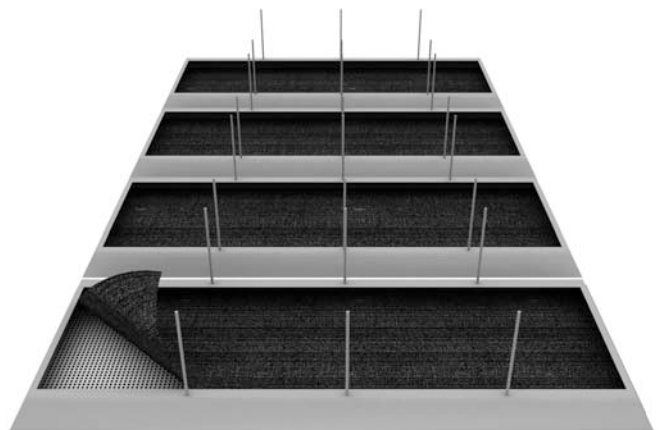

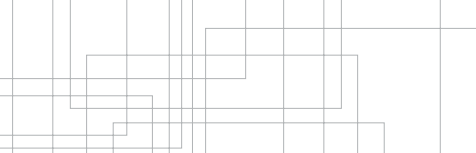



Integra Special
Design Ceilings offer
limitless design
options facilitating the
creation of unique
living environments.



Offering high quality
solutions to all interior
dimensions

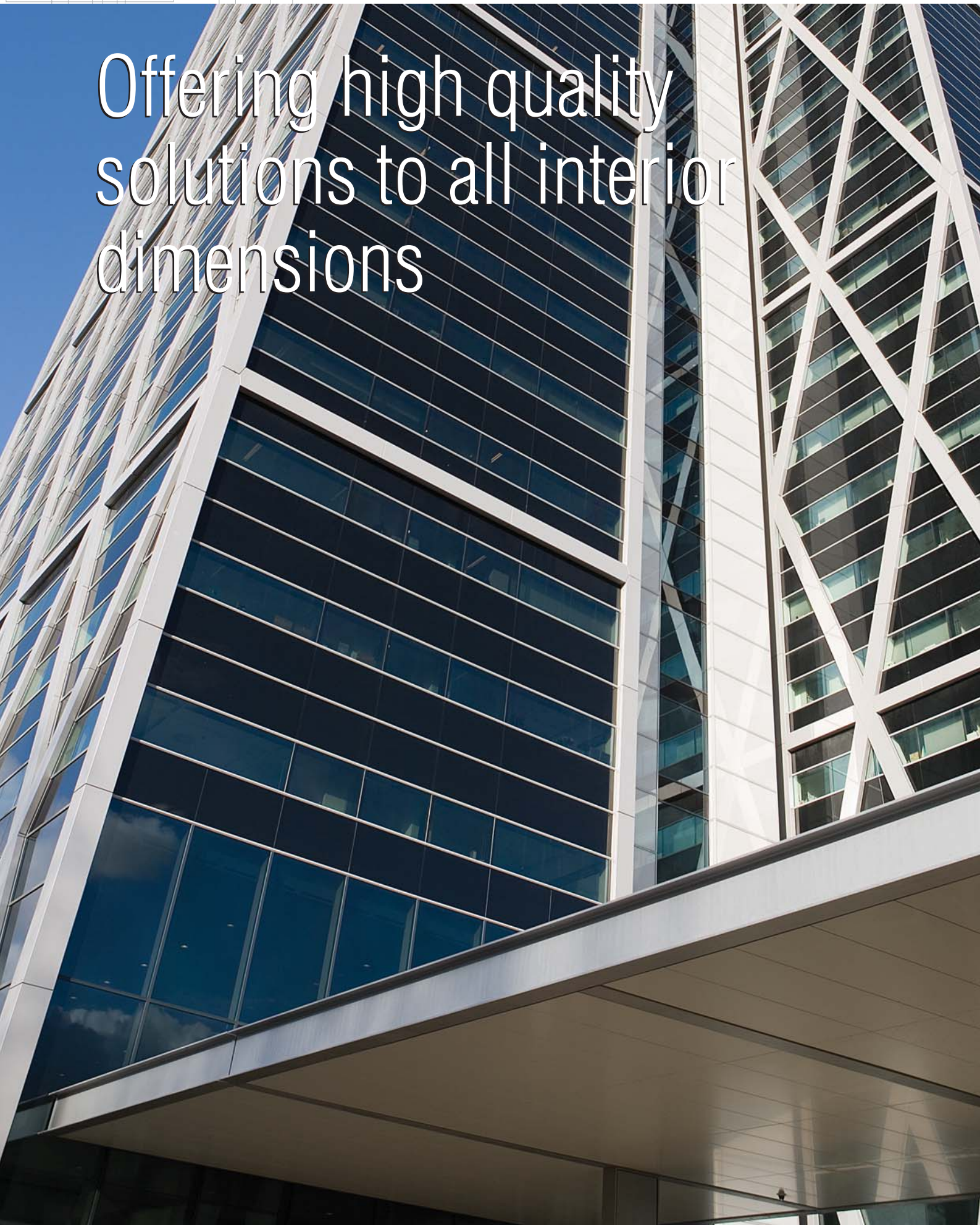

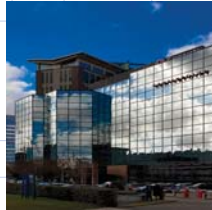

Since 2000, Integra has been providing solutions to architects, interior designers and contractors through its extensive range of products which include; metal ceilings, partition walls and raised access floorings.



Integra offers wide range of high quality products through its extensive line of design alternatives and options incorporation the Tile, Plank, Open Cell, Expanded and fully customised ceiling systems, all of which can be supplied in different shapes, colours and sizes.





Better quality in living and working spaces

SONY HEAD OFFICE / AMSTERDAM

SONY HEAD OFFICE / AMSTERDAM

SPECIALS

METAL CEILING SYSTEMS



INTEGRA METAL CEILING SYSTEMS B.V.

Rak 22 - 1551 NA Westzaan
Postbus 2067 - 1500 GB Zaandam
Tel. +31 (0)75 614 87 22
Fax. +31 (0)75 670 14 97
Internet : www.metalenplafonds.nl
E-mail : info@metalenplafonds.nl